

## VR 090 / 130 P ...

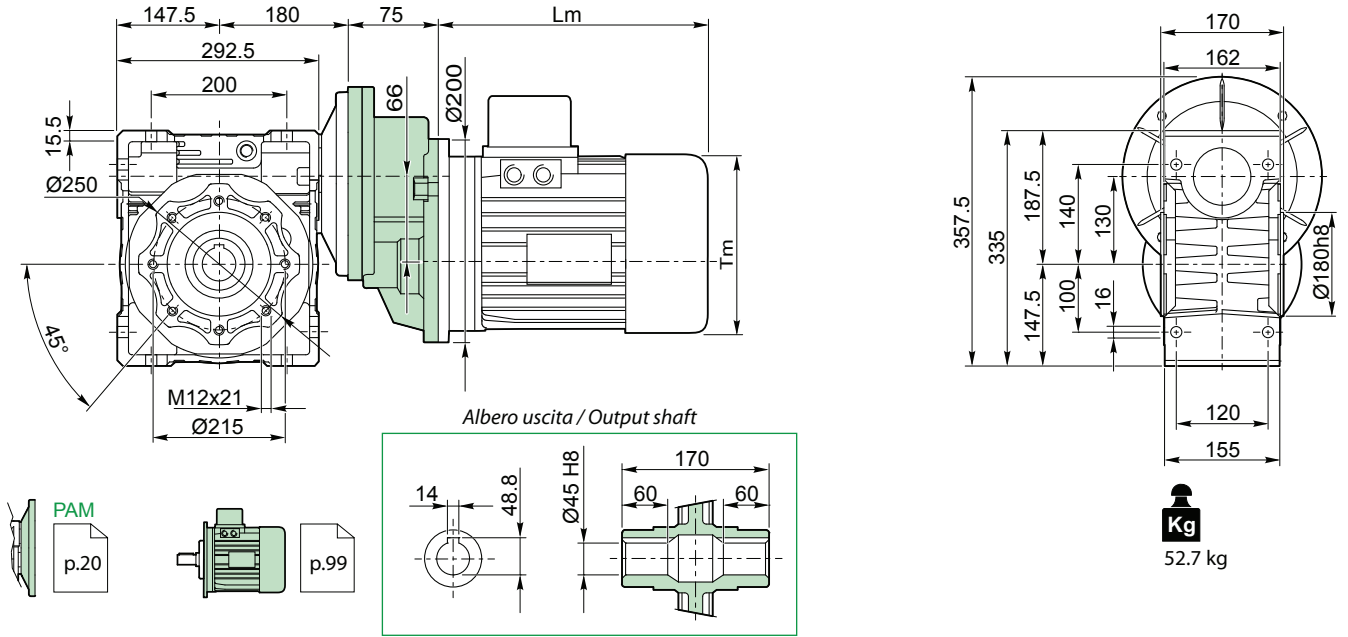

## VR 090 / 130 F...

